

*Ministère  
des Transports*

**Québec**



Direction du Bas-Saint-Laurent –  
Gaspésie – Îles-de-la-Madeleine

## **PROJET D'IMPLANTATION D'UN LIEU D'ENFOUISSEMENT TECHNIQUE À LA RÉDEMPTION**

**DONNÉES DE CIRCULATION**

Septembre 2007

**COMPTAGE EN SECTION DE LA ROUTE MASSÉ ENTRE LA  
ROUTE 132 ET LA ROUTE MELUCQ DE 1995 À 2006**

Section de trafic: 9583001000    SAINTE-JEANNE-D'ARC

de: 95830-01-015 (00000)    RTE 132

à: 95830-01-020 (03391)    rte Melucq

Station: Face au numéro civiq 19

95830-01-020 (02680)

Année	djma	djme	djmh	variation annuelle	nombre de jours	% de camions	30e heure	état
2006	670	720	600		7	4 %	80	officiel
2005	670	720	600	-3 %	0		80	officiel
2004	690	750	620		9	9 %	80	officiel
2003	620	740	500	2 %	0	18 %	110	officiel
2002	610	730	490	-3 %	0		110	officiel
2001	630	750	510	-19 %	8	6 %	110	officiel
2000	780	930	630	-1 %	0		130	officiel
1999	790	950	640	0 %	0		130	officiel
1998	790	950	640	10 %	6	11 %	130	officiel
1997	720	860	580	11 %	0		120	officiel
1996	650	780	520	-6 %	0		110	officiel
1995	690	820	550		5		120	officiel

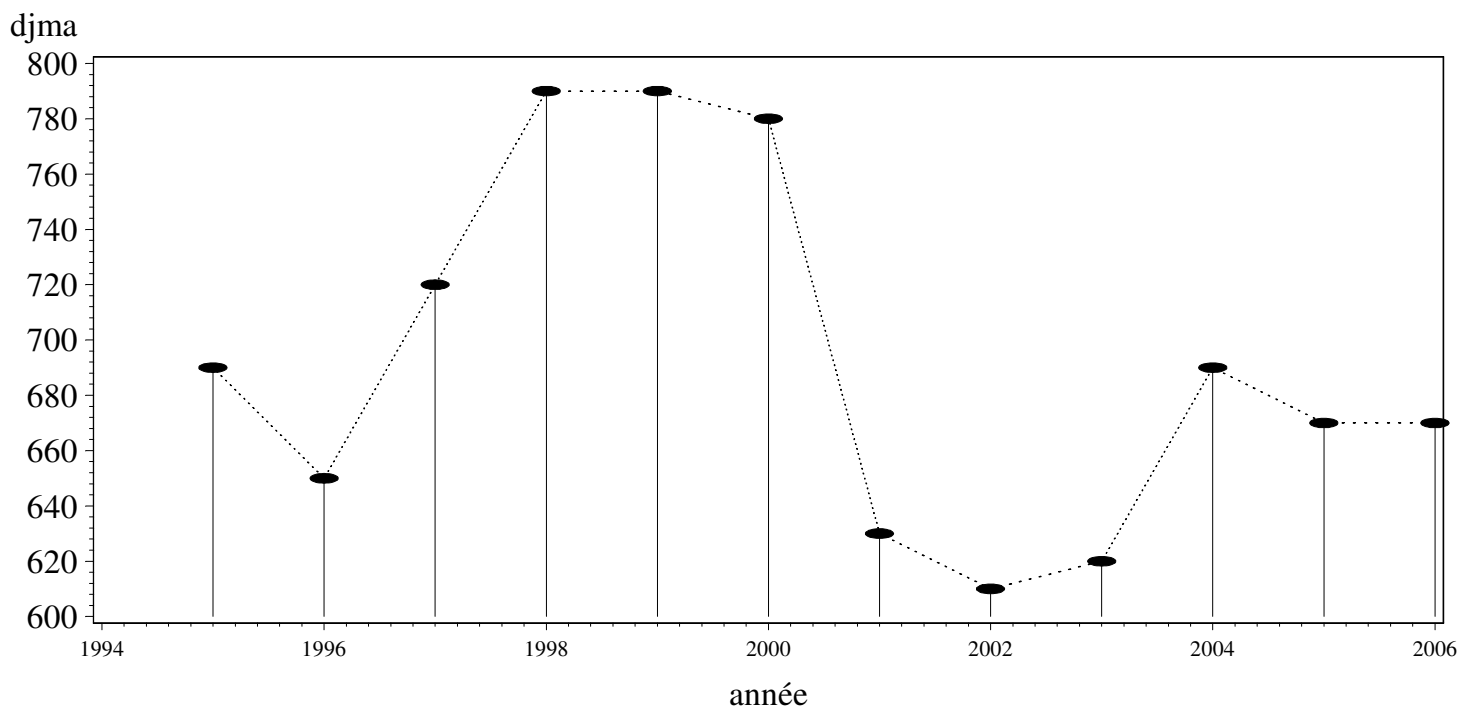

**ÉTUDE DE MOUVEMENTS À L'INTERSECTION  
DE LA ROUTE 132 ET DE LA ROUTE MASSÉ**

Numéro du relevé: 0056971 Type d'étude: Passagers Étude piétons: Direction 1  
 Numéro de l'intersection: 3604 Porteurs (#056972) Direction 2  
 Articulés  
 Municipalité: SAINTE-JEANNE-D'ARC  
 Direction Territoriale: Bas-Saint-Laurent Centre de service: 6506  
 Demandeur: Jean René

Relevé de 7:00 à 19:00  
 Date du relevé (avant-midi): 07-08-01 Mercredi Ensoleillé  
 Date du relevé (après-midi): 07-08-01 Mercredi Nuageux

	route	section de trafic djma officiel	profil	% commercial	djma	djme	djmh	fpi
Nord								
Sud	95830-01-015 (00+000) Route Massé	9583001000 670 (2006)	1	6.4	780	840	700	0.95
Est	00132-20-220 (03+057) ROUTE 132	0013298700 4000 (2006)	5	10.8	3900	5400	2600	0.84
Ouest	00132-20-220 (03+057) ROUTE 132	0013298700 4000 (2006)	5	10.0	4300	6000	3000	0.87

Heure de pointe: 16:15 à 17:15 Djma entrant: 4500  
 Facteur de pointe instantanée: 0.97 % commercial: 10.1

Remarque: Étude d'intersection B. Bussières

Numéro du relevé: 0056971    Municipalité: SAINTE-JEANNE-D'ARC  
 Direction Territoriale: Bas-Saint-Laurent

Avant-midi: 07-08-01 Mercredi  
 Après-midi: 07-08-01 Mercredi  
 Relevé de 7:00 à 19:00

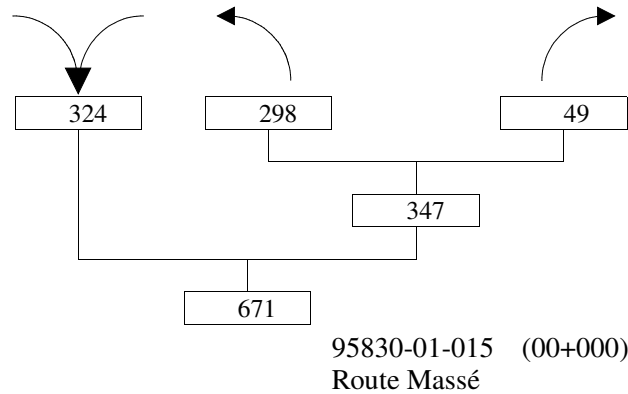
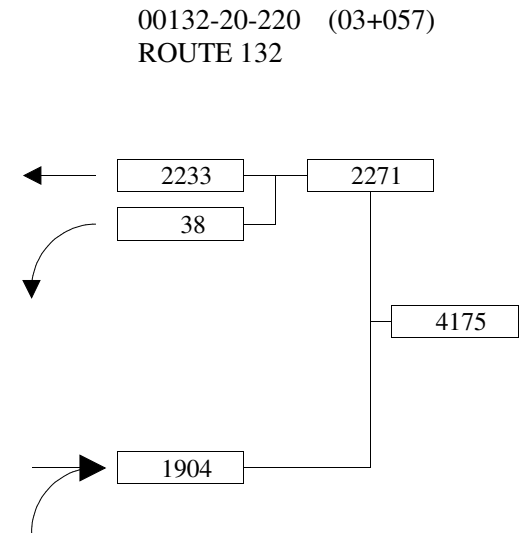
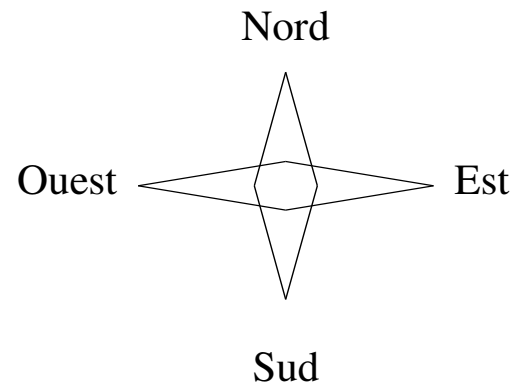
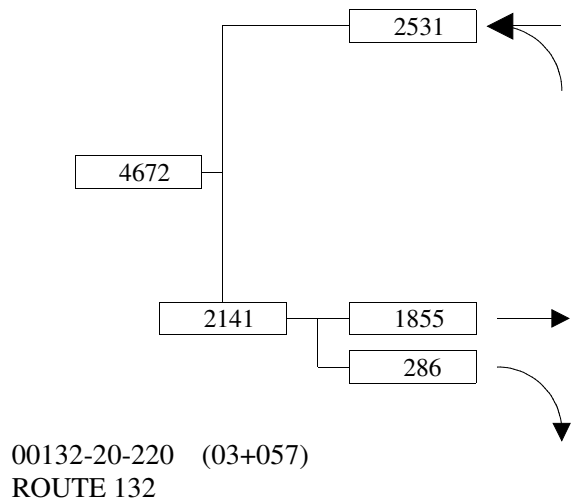

Numéro du relevé: 0056971    Municipalité: SAINTE-JEANNE-D'ARC  
 Direction Territoriale: Bas-Saint-Laurent

Avant-midi: 07-08-01 Mercredi  
 Après-midi: 07-08-01 Mercredi  
 Relevé de 7:00 à 19:00

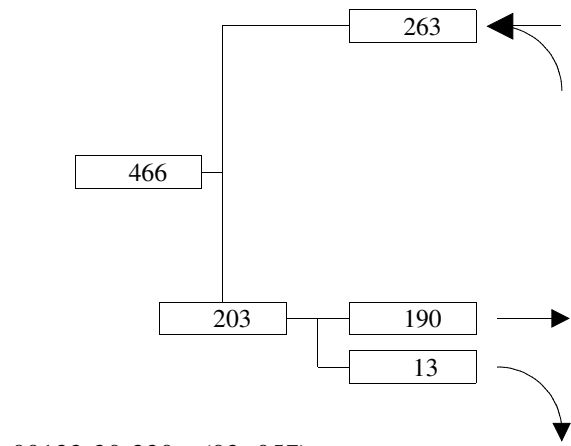

00132-20-220 (03+057)  
 ROUTE 132

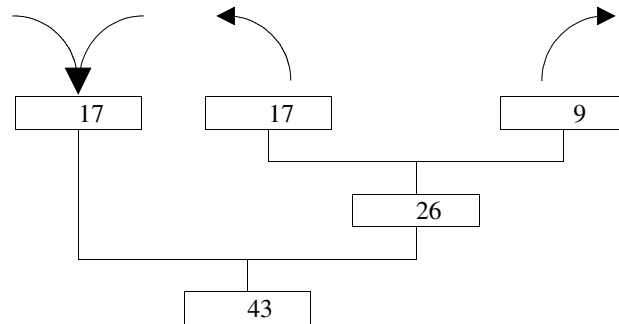
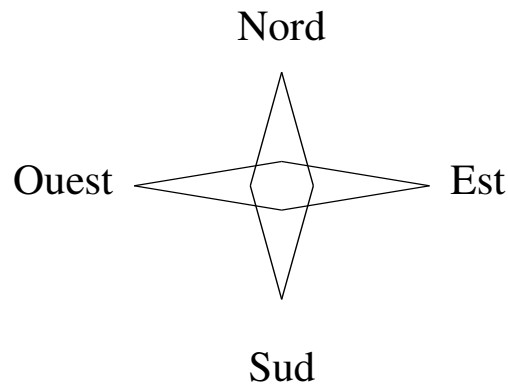

95830-01-015 (00+000)  
 Route Massé

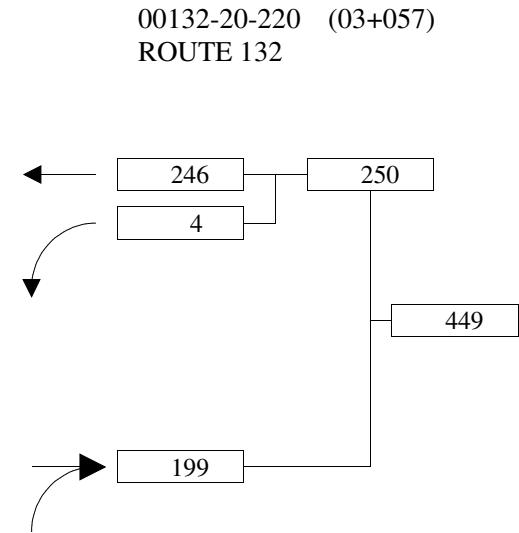

00132-20-220 (03+057)  
 ROUTE 132



Numéro du relevé: 0056971    Municipalité: SAINTE-JEANNE-D'ARC  
 Direction Territoriale: Bas-Saint-Laurent

Avant-midi: 07-08-01 Mercredi  
 Après-midi: 07-08-01 Mercredi  
 Relevé de 7:00 à 19:00

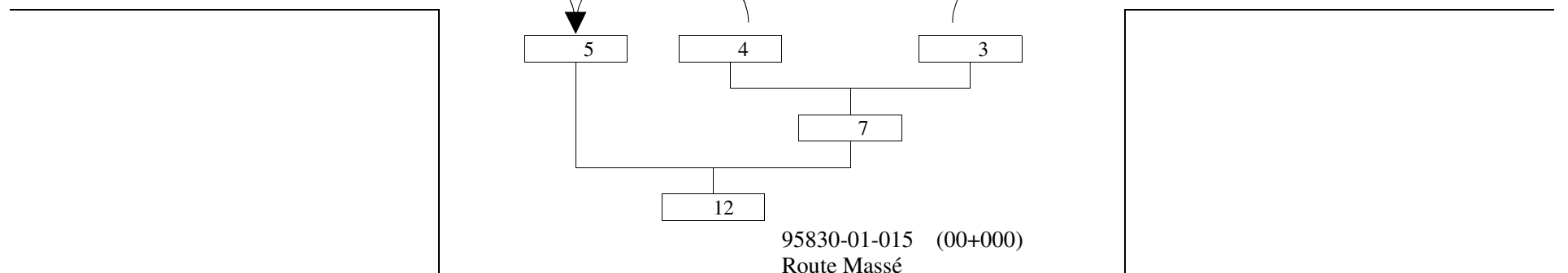
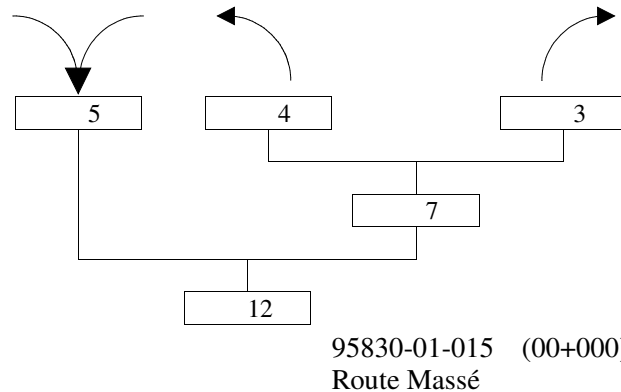
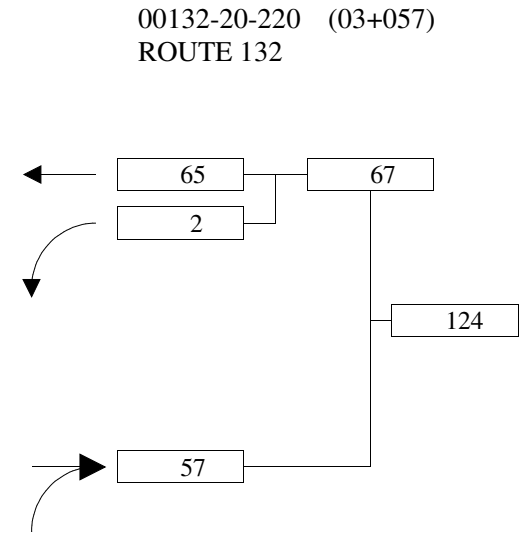
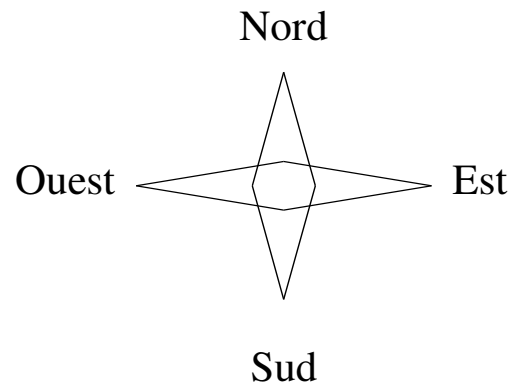
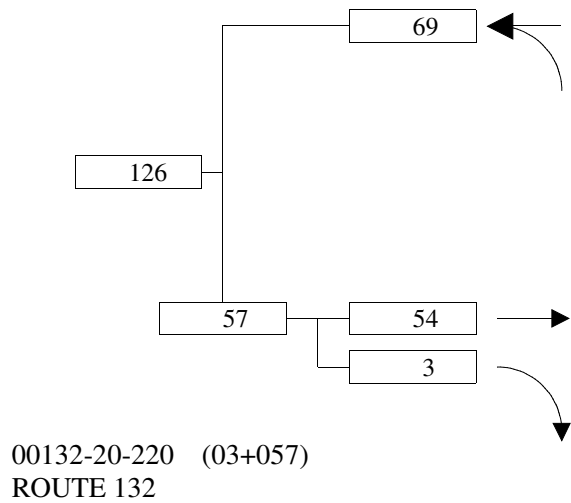



Numéro du relevé: 0056971    Municipalité: SAINTE-JEANNE-D'ARC  
 Direction Territoriale: Bas-Saint-Laurent

Avant-midi: 07-08-01    Mercredi  
 Après-midi: 07-08-01    Mercredi  
 Relevé de 7:00 à 19:00

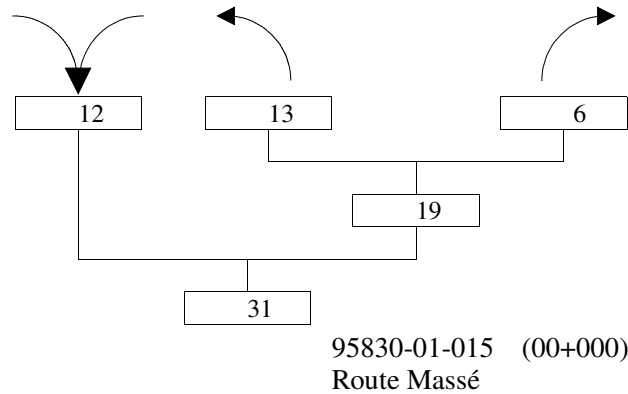
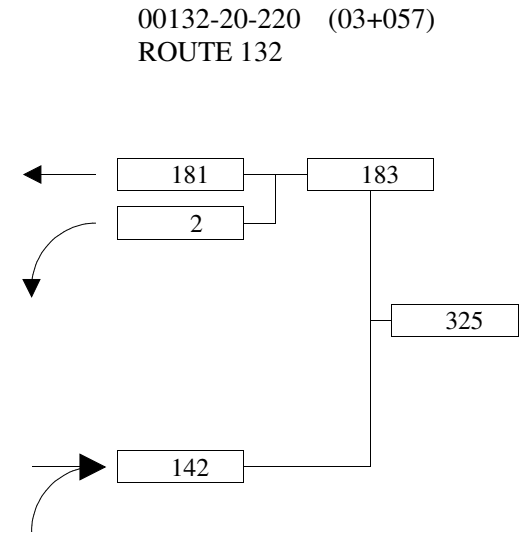
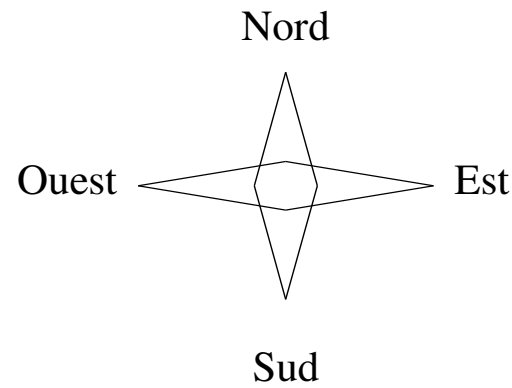
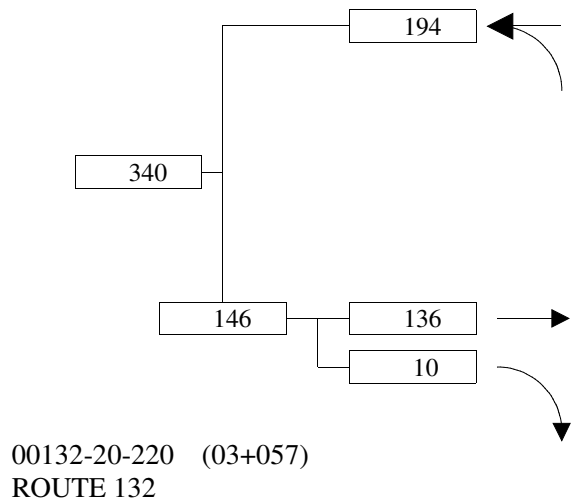

Numéro du relevé: 0056971    Municipalité: SAINTE-JEANNE-D'ARC  
 Direction Territoriale: Bas-Saint-Laurent

Avant-midi: 07-08-01 Mercredi  
 Après-midi: 07-08-01 Mercredi  
 Relevé de 7:00 à 19:00

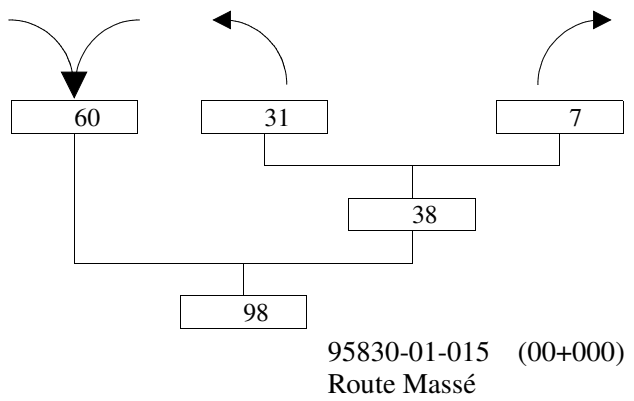
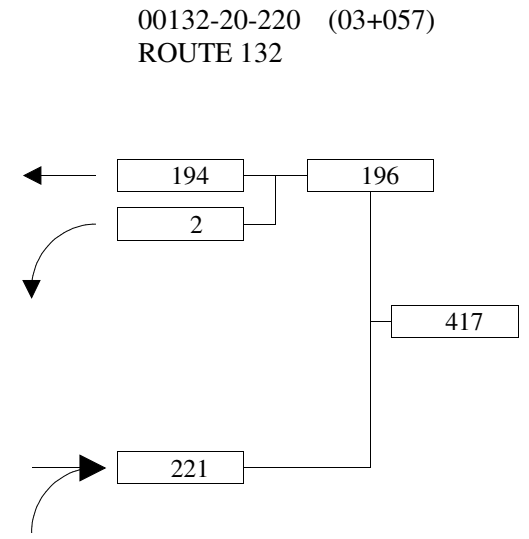
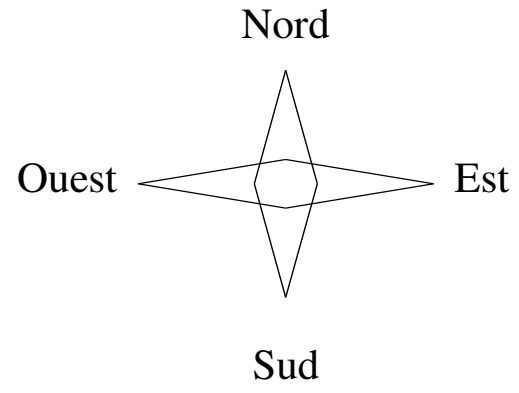
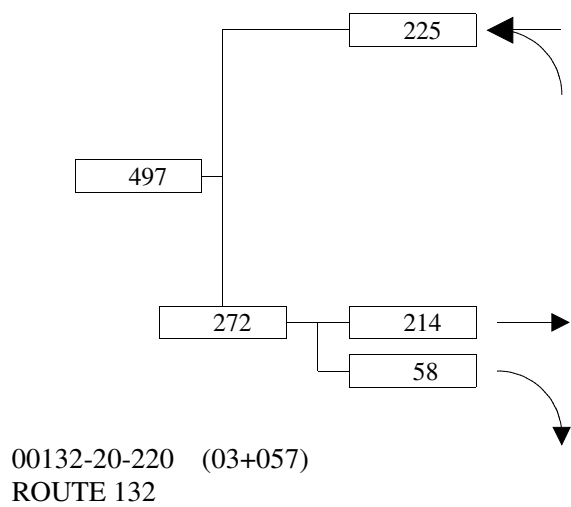

Numéro du relevé: 0056971 Municipalité: SAINTE-JEANNE-D'ARC  
 Direction Territoriale: Bas-Saint-Laurent

Avant-midi: 07-08-01 Mercredi  
 Après-midi: 07-08-01 Mercredi  
 Relevé de 7:00 à 19:00

Nord:  
 Sud: 95830-01-015 (00+000) Route Massé

Est: 00132-20-220 (03+057) ROUTE 132  
 Ouest: 00132-20-220 (03+057) ROUTE 132

	Nord			Total	Sud Route Massé			Total	Est ROUTE 132			Total	Ouest ROUTE 132			Total	Grand Total	% Horaire
	←	↑	→		←	↑	→		←	↑	→		←	↑	→			
7:00- 8:00	0	0	0	0	25	0	5	30	3	122	0	125	0	86	9	95	250	5.3
8:00- 9:00	0	0	0	0	28	0	3	31	1	123	0	124	0	108	9	117	272	5.7
9:00-10:00	0	0	0	0	18	0	4	22	2	197	0	199	0	124	18	142	363	7.6
10:00-11:00	0	0	0	0	25	0	7	32	4	243	0	247	0	154	17	171	450	9.5
11:00-12:00	0	0	0	0	23	0	6	29	5	191	0	196	0	171	19	190	415	8.7
12:00-13:00	0	0	0	0	29	0	2	31	2	218	0	220	0	148	18	166	417	8.8
13:00-14:00	0	0	0	0	32	0	4	36	3	204	0	207	0	175	24	199	442	9.3
14:00-15:00	0	0	0	0	29	0	2	31	5	228	0	233	0	200	22	222	486	10.2
15:00-16:00	0	0	0	0	17	0	6	23	5	207	0	212	0	198	29	227	462	9.7
16:00-17:00	0	0	0	0	28	0	6	34	1	191	0	192	0	205	48	253	479	10.1
17:00-18:00	0	0	0	0	23	0	2	25	3	171	0	174	0	169	50	219	418	8.8
18:00-19:00	0	0	0	0	21	0	2	23	4	138	0	142	0	117	23	140	305	6.4
Total	0	0	0	0	298	0	49	347	38	2233	0	2271	0	1855	286	2141	4759	100
% de approche					85.9	0.0	14.1		1.7	98.3	0.0		0.0	86.6	13.4			

Numéro du relevé: 0056971 Municipalité: SAINTE-JEANNE-D'ARC  
Direction Territoriale: Bas-Saint-Laurent

Avant-midi: 07-08-01 Mercredi  
Après-midi: 07-08-01 Mercredi  
Relevé de 7:00 à 19:00

Nord:  
Sud: 95830-01-015 (00+000) Route Massé

Est: 00132-20-220 (03+057) ROUTE 132  
Ouest: 00132-20-220 (03+057) ROUTE 132

	Nord				Sud Route Massé				Est ROUTE 132				Ouest ROUTE 132				Grand Total	% Horaire
	←	↑	→	Total	←	↑	→	Total	←	↑	→	Total	←	↑	→	Total		
7:00- 8:00	0	0	0	0	1	0	2	3	2	14	0	16	0	19	0	19	38	7.9
8:00- 9:00	0	0	0	0	1	0	1	2	0	14	0	14	0	20	0	20	36	7.5
9:00-10:00	0	0	0	0	3	0	0	3	0	12	0	12	0	27	5	32	47	9.8
10:00-11:00	0	0	0	0	0	0	2	2	0	21	0	21	0	14	1	15	38	7.9
11:00-12:00	0	0	0	0	1	0	1	2	2	21	0	23	0	25	0	25	50	10.4
12:00-13:00	0	0	0	0	2	0	0	2	0	18	0	18	0	17	3	20	40	8.4
13:00-14:00	0	0	0	0	0	0	0	0	0	27	0	27	0	18	1	19	46	9.6
14:00-15:00	0	0	0	0	3	0	1	4	0	28	0	28	0	15	2	17	49	10.2
15:00-16:00	0	0	0	0	1	0	1	2	0	25	0	25	0	8	1	9	36	7.5
16:00-17:00	0	0	0	0	3	0	0	3	0	25	0	25	0	13	0	13	41	8.6
17:00-18:00	0	0	0	0	1	0	1	2	0	26	0	26	0	8	0	8	36	7.5
18:00-19:00	0	0	0	0	1	0	0	1	0	15	0	15	0	6	0	6	22	4.6
<b>Total</b>	<b>0</b>	<b>0</b>	<b>0</b>	<b>0</b>	<b>17</b>	<b>0</b>	<b>9</b>	<b>26</b>	<b>4</b>	<b>246</b>	<b>0</b>	<b>250</b>	<b>0</b>	<b>190</b>	<b>13</b>	<b>203</b>	<b>479</b>	<b>100</b>
% de approche					65.4	0.0	34.6		1.6	98.4	0.0		0.0	93.6	6.4			

Numéro du relevé: 0056971 Municipalité: SAINTE-JEANNE-D'ARC  
Direction Territoriale: Bas-Saint-Laurent

Avant-midi: 07-08-01 Mercredi  
Après-midi: 07-08-01 Mercredi  
Relevé de 7:00 à 19:00

Nord: Sud: 95830-01-015 (00+000) Route Massé

Est: 00132-20-220 (03+057) ROUTE 132  
Ouest: 00132-20-220 (03+057) ROUTE 132

	Nord			Total	Sud Route Massé			Total	Est ROUTE 132			Total	Ouest ROUTE 132			Total	Grand Total	% Horaire
	←	↑	→		←	↑	→		←	↑	→		←	↑	→			
7:00- 8:00	0	0	0	0	1	0	0	1	1	5	0	6	0	4	0	4	11	8.4
8:00- 9:00	0	0	0	0	0	0	1	1	0	5	0	5	0	5	0	5	11	8.4
9:00-10:00	0	0	0	0	1	0	0	1	0	2	0	2	0	11	1	12	15	11.5
10:00-11:00	0	0	0	0	0	0	1	1	0	4	0	4	0	5	1	6	11	8.4
11:00-12:00	0	0	0	0	0	0	1	1	1	6	0	7	0	9	0	9	17	13.0
12:00-13:00	0	0	0	0	0	0	0	0	0	6	0	6	0	6	0	6	12	9.2
13:00-14:00	0	0	0	0	0	0	0	0	0	7	0	7	0	1	0	1	8	6.1
14:00-15:00	0	0	0	0	0	0	0	0	0	11	0	11	0	3	1	4	15	11.5
15:00-16:00	0	0	0	0	1	0	0	1	0	5	0	5	0	3	0	3	9	6.9
16:00-17:00	0	0	0	0	1	0	0	1	0	3	0	3	0	2	0	2	6	4.6
17:00-18:00	0	0	0	0	0	0	0	0	0	9	0	9	0	3	0	3	12	9.2
18:00-19:00	0	0	0	0	0	0	0	0	0	2	0	2	0	2	0	2	4	3.1
<b>Total</b>	<b>0</b>	<b>0</b>	<b>0</b>	<b>0</b>	<b>4</b>	<b>0</b>	<b>3</b>	<b>7</b>	<b>2</b>	<b>65</b>	<b>0</b>	<b>67</b>	<b>0</b>	<b>54</b>	<b>3</b>	<b>57</b>	<b>131</b>	<b>100</b>
% de approche					57.1	0.0	42.9		3.0	97.0	0.0		0.0	94.7	5.3			

Numéro du relevé: 0056971 Municipalité: SAINTE-JEANNE-D'ARC  
Direction Territoriale: Bas-Saint-Laurent

Avant-midi: 07-08-01 Mercredi  
Après-midi: 07-08-01 Mercredi  
Relevé de 7:00 à 19:00

Nord: Sud: 95830-01-015 (00+000) Route Massé

Est: 00132-20-220 (03+057) ROUTE 132  
Ouest: 00132-20-220 (03+057) ROUTE 132

	Nord				Sud Route Massé				Est ROUTE 132				Ouest ROUTE 132				Grand Total	% Horaire
	←	↑	→	Total	←	↑	→	Total	←	↑	→	Total	←	↑	→	Total		
7:00- 8:00	0	0	0	0	0	0	2	2	1	9	0	10	0	15	0	15	27	7.8
8:00- 9:00	0	0	0	0	1	0	0	1	0	9	0	9	0	15	0	15	25	7.2
9:00-10:00	0	0	0	0	2	0	0	2	0	10	0	10	0	16	4	20	32	9.2
10:00-11:00	0	0	0	0	0	0	1	1	0	17	0	17	0	9	0	9	27	7.8
11:00-12:00	0	0	0	0	1	0	0	1	1	15	0	16	0	16	0	16	33	9.5
12:00-13:00	0	0	0	0	2	0	0	2	0	12	0	12	0	11	3	14	28	8.0
13:00-14:00	0	0	0	0	0	0	0	0	0	20	0	20	0	17	1	18	38	10.9
14:00-15:00	0	0	0	0	3	0	1	4	0	17	0	17	0	12	1	13	34	9.8
15:00-16:00	0	0	0	0	0	0	1	1	0	20	0	20	0	5	1	6	27	7.8
16:00-17:00	0	0	0	0	2	0	0	2	0	22	0	22	0	11	0	11	35	10.1
17:00-18:00	0	0	0	0	1	0	1	2	0	17	0	17	0	5	0	5	24	6.9
18:00-19:00	0	0	0	0	1	0	0	1	0	13	0	13	0	4	0	4	18	5.2
<b>Total</b>	<b>0</b>	<b>0</b>	<b>0</b>	<b>0</b>	<b>13</b>	<b>0</b>	<b>6</b>	<b>19</b>	<b>2</b>	<b>181</b>	<b>0</b>	<b>183</b>	<b>0</b>	<b>136</b>	<b>10</b>	<b>146</b>	<b>348</b>	<b>100</b>
% de approche					68.4	0.0	31.6		1.1	98.9	0.0		0.0	93.2	6.8			

Numéro du relevé: 0056971 Municipalité: SAINTE-JEANNE-D'ARC  
Direction Territoriale: Bas-Saint-Laurent

Avant-midi: 07-08-01 Mercredi  
Après-midi: 07-08-01 Mercredi  
Relevé de 7:00 à 19:00

Nord:  
Sud: 95830-01-015 (00+000) Route Massé

Est: 00132-20-220 (03+057) ROUTE 132  
Ouest: 00132-20-220 (03+057) ROUTE 132

	Nord				Sud Route Massé				Est ROUTE 132				Ouest ROUTE 132				Grand Total
	←	↑	→	Total	←	↑	→	Total	←	↑	→	Total	←	↑	→	Total	
9:00- 9:15	0	0	0	0	4	0	0	4	0	39	0	39	0	22	4	26	69
9:15- 9:30	0	0	0	0	4	0	1	5	2	56	0	58	0	35	3	38	101
9:30- 9:45	0	0	0	0	3	0	3	6	0	50	0	50	0	32	4	36	92
9:45-10:00	0	0	0	0	7	0	0	7	0	52	0	52	0	35	7	42	101
Total pointe					18		4	22	2	197		199		124	18	142	363
fpi					0.64		0.33	0.79	0.25	0.88		0.86		0.89	0.64	0.85	0.90
% commercial					16.7		0.0	13.6	0.0	6.1		6.0		21.8	27.8	22.5	12.9
13:00-13:15	0	0	0	0	9	0	2	11	1	56	0	57	0	46	3	49	117
13:15-13:30	0	0	0	0	4	0	1	5	0	34	0	34	0	41	9	50	89
13:30-13:45	0	0	0	0	6	0	0	6	0	59	0	59	0	43	8	51	116
13:45-14:00	0	0	0	0	13	0	1	14	2	55	0	57	0	45	4	49	120
Total pointe					32		4	36	3	204		207		175	24	199	442
fpi					0.62		0.50	0.64	0.38	0.86		0.88		0.95	0.67	0.98	0.92
% commercial					0.0		0.0	0.0	0.0	13.2		13.0		10.3	4.2	9.5	10.4
16:15-16:30	0	0	0	0	8	0	2	10	0	43	0	43	0	58	20	78	131
16:30-16:45	0	0	0	0	8	0	1	9	0	53	0	53	0	57	11	68	130
16:45-17:00	0	0	0	0	7	0	3	10	1	41	0	42	0	52	12	64	116
17:00-17:15	0	0	0	0	8	0	1	9	1	57	0	58	0	47	15	62	129
Total pointe					31		7	38	2	194		196		214	58	272	506
fpi					0.97		0.58	0.95	0.50	0.85		0.84		0.92	0.73	0.87	0.97
% commercial					12.9		14.3	13.2	0.0	15.5		15.3		6.5	0.0	5.1	9.7





Numéro du relevé: 0056971 Municipalité: SAINTE-JEANNE-D'ARC  
Direction Territoriale: Bas-Saint-Laurent

Avant-midi: 07-08-01 Mercredi  
Après-midi: 07-08-01 Mercredi  
Relevé de 7:00 à 19:00

Nord:  
Sud: 95830-01-015 (00+000) Route Massé

Est: 00132-20-220 (03+057) ROUTE 132  
Ouest: 00132-20-220 (03+057) ROUTE 132

Type1: Direction 1 Type2: Direction 2 Type3: --nil--

	Nord				Sud Route Massé				Est ROUTE 132				Ouest ROUTE 132				Grand Total
	o->e	e->o	Type3	Total	e->o	o->e	Type3	Total	n->s	s->n	Type3	Total	s->n	n->s	Type3	Total	
	13:00-13:15	0	0	0	0	0	0	0	0	0	0	0	0	0	0	0	
13:15-13:30	0	0	0	0	0	0	0	0	0	0	0	0	0	0	0	0	0
13:30-13:45	0	0	0	0	0	0	0	0	0	0	0	0	0	0	0	0	0
13:45-14:00	0	0	0	0	0	0	0	0	0	0	0	0	0	0	0	0	0
14:00-14:15	0	0	0	0	0	0	0	0	0	0	0	0	0	0	0	0	0
14:15-14:30	0	0	0	0	0	0	0	0	0	0	0	0	0	0	0	0	0
14:30-14:45	0	0	0	0	0	0	0	0	0	0	0	0	0	0	0	0	0
14:45-15:00	0	0	0	0	0	0	0	0	0	0	0	0	0	0	0	0	0
15:00-15:15	0	0	0	0	0	0	0	0	0	0	0	0	0	0	0	0	0
15:15-15:30	0	0	0	0	0	0	0	0	0	0	0	0	0	0	0	0	0
15:30-15:45	0	0	0	0	0	0	0	0	0	0	0	0	0	0	0	0	0
15:45-16:00	0	0	0	0	0	0	0	0	0	0	0	0	0	0	0	0	0
16:00-16:15	0	0	0	0	0	0	0	0	0	0	0	0	0	0	0	0	0
16:15-16:30	0	0	0	0	0	0	0	0	0	0	0	0	0	0	0	0	0
16:30-16:45	0	0	0	0	0	0	0	0	0	0	0	0	0	0	0	0	0
16:45-17:00	0	0	0	0	0	0	0	0	0	0	0	0	0	0	0	0	0
17:00-17:15	0	0	0	0	0	0	0	0	0	0	0	0	0	0	0	0	0
17:15-17:30	0	0	0	0	0	0	0	0	0	0	0	0	0	0	0	0	0
17:30-17:45	0	0	0	0	0	0	0	0	0	0	0	0	0	0	0	0	0
17:45-18:00	0	0	0	0	0	0	0	0	0	0	0	0	0	0	0	0	0
18:00-18:15	0	0	0	0	0	0	0	0	0	0	0	0	0	0	0	0	0
18:15-18:30	0	0	0	0	0	0	0	0	0	0	0	0	0	0	0	0	0
18:30-18:45	0	0	0	0	0	0	0	0	0	0	0	0	0	0	0	0	0
18:45-19:00	0	0	0	0	0	0	0	0	0	0	0	0	0	0	0	0	0
<b>Total</b>	0	0	0	0	2	2	0	4	1	0	0	1	2	2	0	4	9

Numéro du relevé: 0056971 Municipalité: SAINTE-JEANNE-D'ARC  
Direction Territoriale: Bas-Saint-Laurent

Avant-midi: 07-08-01 Mercredi  
Après-midi: 07-08-01 Mercredi  
Relevé de 7:00 à 19:00

Nord:  
Sud: 95830-01-015 (00+000) Route Massé

Est: 00132-20-220 (03+057) ROUTE 132  
Ouest: 00132-20-220 (03+057) ROUTE 132

	Nord				Sud Route Massé				Est ROUTE 132				Ouest ROUTE 132				Grand Total	%
	←	↑	→	Total	←	↑	→	Total	←	↑	→	Total	←	↑	→	Total		
7:00- 7:15	0	0	0	0	3	0	1	4	1	31	0	32	0	17	1	18	54	1.1
7:15- 7:30	0	0	0	0	10	0	0	10	0	27	0	27	0	26	2	28	65	1.4
7:30- 7:45	0	0	0	0	7	0	2	9	0	37	0	37	0	24	2	26	72	1.5
7:45- 8:00	0	0	0	0	5	0	2	7	2	27	0	29	0	19	4	23	59	1.2
8:00- 8:15	0	0	0	0	5	0	0	5	0	33	0	33	0	22	3	25	63	1.3
8:15- 8:30	0	0	0	0	9	0	0	9	0	19	0	19	0	31	0	31	59	1.2
8:30- 8:45	0	0	0	0	8	0	2	10	1	45	0	46	0	31	4	35	91	1.9
8:45- 9:00	0	0	0	0	6	0	1	7	0	26	0	26	0	24	2	26	59	1.2
9:00- 9:15	0	0	0	0	4	0	0	4	0	39	0	39	0	22	4	26	69	1.4
9:15- 9:30	0	0	0	0	4	0	1	5	2	56	0	58	0	35	3	38	101	2.1
9:30- 9:45	0	0	0	0	3	0	3	6	0	50	0	50	0	32	4	36	92	1.9
9:45-10:00	0	0	0	0	7	0	0	7	0	52	0	52	0	35	7	42	101	2.1
10:00-10:15	0	0	0	0	9	0	2	11	0	74	0	74	0	31	4	35	120	2.5
10:15-10:30	0	0	0	0	4	0	2	6	3	57	0	60	0	28	5	33	99	2.1
10:30-10:45	0	0	0	0	5	0	0	5	1	67	0	68	0	45	6	51	124	2.6
10:45-11:00	0	0	0	0	7	0	3	10	0	45	0	45	0	50	2	52	107	2.2
11:00-11:15	0	0	0	0	7	0	2	9	1	47	0	48	0	35	5	40	97	2.0
11:15-11:30	0	0	0	0	7	0	2	9	1	60	0	61	0	49	3	52	122	2.6
11:30-11:45	0	0	0	0	5	0	1	6	1	45	0	46	0	45	6	51	103	2.2
11:45-12:00	0	0	0	0	4	0	1	5	2	39	0	41	0	42	5	47	93	2.0
12:00-12:15	0	0	0	0	4	0	0	4	0	53	0	53	0	47	4	51	108	2.3
12:15-12:30	0	0	0	0	5	0	1	6	2	60	0	62	0	35	5	40	108	2.3
12:30-12:45	0	0	0	0	10	0	0	10	0	52	0	52	0	37	5	42	104	2.2
12:45-13:00	0	0	0	0	10	0	1	11	0	53	0	53	0	29	4	33	97	2.0

Numéro du relevé: 0056971 Municipalité: SAINTE-JEANNE-D'ARC  
Direction Territoriale: Bas-Saint-Laurent

Avant-midi: 07-08-01 Mercredi  
Après-midi: 07-08-01 Mercredi  
Relevé de 7:00 à 19:00

Nord:  
Sud: 95830-01-015 (00+000) Route Massé

Est: 00132-20-220 (03+057) ROUTE 132  
Ouest: 00132-20-220 (03+057) ROUTE 132

	Nord				Sud Route Massé				Est ROUTE 132				Ouest ROUTE 132				Grand Total	%
	←	↑	→	Total	←	↑	→	Total	←	↑	→	Total	←	↑	→	Total		
13:00-13:15	0	0	0	0	9	0	2	11	1	56	0	57	0	46	3	49	117	2.5
13:15-13:30	0	0	0	0	4	0	1	5	0	34	0	34	0	41	9	50	89	1.9
13:30-13:45	0	0	0	0	6	0	0	6	0	59	0	59	0	43	8	51	116	2.4
13:45-14:00	0	0	0	0	13	0	1	14	2	55	0	57	0	45	4	49	120	2.5
14:00-14:15	0	0	0	0	6	0	1	7	1	45	0	46	0	52	7	59	112	2.4
14:15-14:30	0	0	0	0	12	0	0	12	1	65	0	66	0	51	10	61	139	2.9
14:30-14:45	0	0	0	0	5	0	0	5	1	55	0	56	0	56	3	59	120	2.5
14:45-15:00	0	0	0	0	6	0	1	7	2	63	0	65	0	41	2	43	115	2.4
15:00-15:15	0	0	0	0	3	0	2	5	1	45	0	46	0	44	8	52	103	2.2
15:15-15:30	0	0	0	0	4	0	0	4	3	30	0	33	0	67	9	76	113	2.4
15:30-15:45	0	0	0	0	3	0	4	7	0	49	0	49	0	43	7	50	106	2.2
15:45-16:00	0	0	0	0	7	0	0	7	1	83	0	84	0	44	5	49	140	2.9
16:00-16:15	0	0	0	0	5	0	0	5	0	54	0	54	0	38	5	43	102	2.1
16:15-16:30	0	0	0	0	8	0	2	10	0	43	0	43	0	58	20	78	131	2.8
16:30-16:45	0	0	0	0	8	0	1	9	0	53	0	53	0	57	11	68	130	2.7
16:45-17:00	0	0	0	0	7	0	3	10	1	41	0	42	0	52	12	64	116	2.4
17:00-17:15	0	0	0	0	8	0	1	9	1	57	0	58	0	47	15	62	129	2.7
17:15-17:30	0	0	0	0	5	0	0	5	0	40	0	40	0	45	17	62	107	2.2
17:30-17:45	0	0	0	0	7	0	1	8	2	38	0	40	0	37	13	50	98	2.1
17:45-18:00	0	0	0	0	3	0	0	3	0	36	0	36	0	40	5	45	84	1.8
18:00-18:15	0	0	0	0	5	0	0	5	1	36	0	37	0	38	7	45	87	1.8
18:15-18:30	0	0	0	0	5	0	2	7	0	44	0	44	0	21	8	29	80	1.7
18:30-18:45	0	0	0	0	5	0	0	5	1	29	0	30	0	29	6	35	70	1.5
18:45-19:00	0	0	0	0	6	0	0	6	2	29	0	31	0	29	2	31	68	1.4

Numéro du relevé: 0056971 Municipalité: SAINTE-JEANNE-D'ARC  
Direction Territoriale: Bas-Saint-Laurent

Avant-midi: 07-08-01 Mercredi  
Après-midi: 07-08-01 Mercredi  
Relevé de 7:00 à 19:00

Nord:  
Sud: 95830-01-015 (00+000) Route Massé

Est: 00132-20-220 (03+057) ROUTE 132  
Ouest: 00132-20-220 (03+057) ROUTE 132

	Nord				Sud Route Massé				Est ROUTE 132				Ouest ROUTE 132				Grand Total	%
	←	↑	→	Total	←	↑	→	Total	←	↑	→	Total	←	↑	→	Total		
7:00- 7:15	0	0	0	0	0	0	1	1	1	5	0	6	0	4	0	4	11	2.3
7:15- 7:30	0	0	0	0	1	0	0	1	0	4	0	4	0	8	0	8	13	2.7
7:30- 7:45	0	0	0	0	0	0	0	0	0	4	0	4	0	3	0	3	7	1.5
7:45- 8:00	0	0	0	0	0	0	1	1	1	1	0	2	0	4	0	4	7	1.5
8:00- 8:15	0	0	0	0	0	0	0	0	0	4	0	4	0	1	0	1	5	1.0
8:15- 8:30	0	0	0	0	1	0	0	1	0	2	0	2	0	4	0	4	7	1.5
8:30- 8:45	0	0	0	0	0	0	0	0	0	6	0	6	0	7	0	7	13	2.7
8:45- 9:00	0	0	0	0	0	0	1	1	0	2	0	2	0	8	0	8	11	2.3
9:00- 9:15	0	0	0	0	0	0	0	0	0	3	0	3	0	7	1	8	11	2.3
9:15- 9:30	0	0	0	0	1	0	0	1	0	4	0	4	0	5	1	6	11	2.3
9:30- 9:45	0	0	0	0	0	0	0	0	0	4	0	4	0	10	2	12	16	3.3
9:45-10:00	0	0	0	0	2	0	0	2	0	1	0	1	0	5	1	6	9	1.9
10:00-10:15	0	0	0	0	0	0	0	0	0	6	0	6	0	3	0	3	9	1.9
10:15-10:30	0	0	0	0	0	0	1	1	0	7	0	7	0	3	0	3	11	2.3
10:30-10:45	0	0	0	0	0	0	0	0	0	6	0	6	0	4	1	5	11	2.3
10:45-11:00	0	0	0	0	0	0	1	1	0	2	0	2	0	4	0	4	7	1.5
11:00-11:15	0	0	0	0	0	0	0	0	1	4	0	5	0	3	0	3	8	1.7
11:15-11:30	0	0	0	0	0	0	1	1	1	7	0	8	0	8	0	8	17	3.5
11:30-11:45	0	0	0	0	0	0	0	0	0	4	0	4	0	9	0	9	13	2.7
11:45-12:00	0	0	0	0	1	0	0	1	0	6	0	6	0	5	0	5	12	2.5
12:00-12:15	0	0	0	0	1	0	0	1	0	3	0	3	0	6	0	6	10	2.1
12:15-12:30	0	0	0	0	0	0	0	0	0	8	0	8	0	3	1	4	12	2.5
12:30-12:45	0	0	0	0	1	0	0	1	0	5	0	5	0	2	2	4	10	2.1
12:45-13:00	0	0	0	0	0	0	0	0	0	2	0	2	0	6	0	6	8	1.7

Numéro du relevé: 0056971 Municipalité: SAINTE-JEANNE-D'ARC  
Direction Territoriale: Bas-Saint-Laurent

Avant-midi: 07-08-01 Mercredi  
Après-midi: 07-08-01 Mercredi  
Relevé de 7:00 à 19:00

Nord:  
Sud: 95830-01-015 (00+000) Route Massé

Est: 00132-20-220 (03+057) ROUTE 132  
Ouest: 00132-20-220 (03+057) ROUTE 132

	Nord				Sud Route Massé				Est ROUTE 132				Ouest ROUTE 132				Grand Total	%
	←	↑	→	Total	←	↑	→	Total	←	↑	→	Total	←	↑	→	Total		
13:00-13:15	0	0	0	0	0	0	0	0	0	9	0	9	0	4	0	4	13	2.7
13:15-13:30	0	0	0	0	0	0	0	0	0	6	0	6	0	7	0	7	13	2.7
13:30-13:45	0	0	0	0	0	0	0	0	0	9	0	9	0	4	0	4	13	2.7
13:45-14:00	0	0	0	0	0	0	0	0	0	3	0	3	0	3	1	4	7	1.5
14:00-14:15	0	0	0	0	0	0	1	1	0	7	0	7	0	5	1	6	14	2.9
14:15-14:30	0	0	0	0	2	0	0	2	0	9	0	9	0	4	1	5	16	3.3
14:30-14:45	0	0	0	0	0	0	0	0	0	8	0	8	0	2	0	2	10	2.1
14:45-15:00	0	0	0	0	1	0	0	1	0	4	0	4	0	4	0	4	9	1.9
15:00-15:15	0	0	0	0	0	0	0	0	0	7	0	7	0	1	1	2	9	1.9
15:15-15:30	0	0	0	0	0	0	0	0	0	1	0	1	0	3	0	3	4	0.8
15:30-15:45	0	0	0	0	1	0	1	2	0	3	0	3	0	3	0	3	8	1.7
15:45-16:00	0	0	0	0	0	0	0	0	0	14	0	14	0	1	0	1	15	3.1
16:00-16:15	0	0	0	0	0	0	0	0	0	6	0	6	0	2	0	2	8	1.7
16:15-16:30	0	0	0	0	2	0	0	2	0	6	0	6	0	2	0	2	10	2.1
16:30-16:45	0	0	0	0	1	0	0	1	0	8	0	8	0	4	0	4	13	2.7
16:45-17:00	0	0	0	0	0	0	0	0	0	5	0	5	0	5	0	5	10	2.1
17:00-17:15	0	0	0	0	1	0	1	2	0	11	0	11	0	3	0	3	16	3.3
17:15-17:30	0	0	0	0	0	0	0	0	0	4	0	4	0	2	0	2	6	1.3
17:30-17:45	0	0	0	0	0	0	0	0	0	4	0	4	0	1	0	1	5	1.0
17:45-18:00	0	0	0	0	0	0	0	0	0	7	0	7	0	2	0	2	9	1.9
18:00-18:15	0	0	0	0	0	0	0	0	0	4	0	4	0	3	0	3	7	1.5
18:15-18:30	0	0	0	0	0	0	0	0	0	6	0	6	0	2	0	2	8	1.7
18:30-18:45	0	0	0	0	0	0	0	0	0	3	0	3	0	1	0	1	4	0.8
18:45-19:00	0	0	0	0	1	0	0	1	0	2	0	2	0	0	0	0	3	0.6

**ÉTUDE DE MOUVEMENTS À L'INTERSECTION DE  
LA ROUTE MASSÉ ET DE LA RUE VIENS (8<sup>e</sup> RANG)**

Numéro du relevé: 0056561      Type d'étude: Passagers      Étude piétons: Direction 1  
 Numéro de l'intersection: 3622      Porteurs      (#056562)      Direction 2  
 Municipalité: LA REDEMPTION      Articulés  
 Direction Territoriale: Bas-Saint-Laurent      Centre de service: 6506  
 Demandeur: Jean René

Relevé de 7:00 à 19:00  
 Date du relevé (avant-midi): 07-08-01 Mercredi      Ensoleillé  
 Date du relevé (après-midi): 07-08-01 Mercredi      Nuageux

	route	section de trafic djma officiel	profil	% commercial	djma	djme	djmh	fpi
Nord	95830-01-020 (03+076) Route Massé	9583001000 670 (2006)(>20%)	1	4.6	1000	1090	900	0.80
Sud	95830-01-020 (03+077) Route Massé	9583001000 670 (2006)(>20%)	1	4.7	1050	1140	940	0.94
Est								
Ouest	L -01-001 (00+000) Rte Viens	L000004194	1	1.3	440	480	390	0.71

Heure de pointe: 12:00 à 13:00      Djma entrant: 1250  
 Facteur de pointe instantanée: 0.90      % commercial: 4.1

Remarque: Étude d'intersection B.Bussières

Numéro du relevé: 0056561 Municipalité: LA REDEMPTION  
 Direction Territoriale: Bas-Saint-Laurent

Avant-midi: 07-08-01 Mercredi  
 Après-midi: 07-08-01 Mercredi  
 Relevé de 7:00 à 19:00

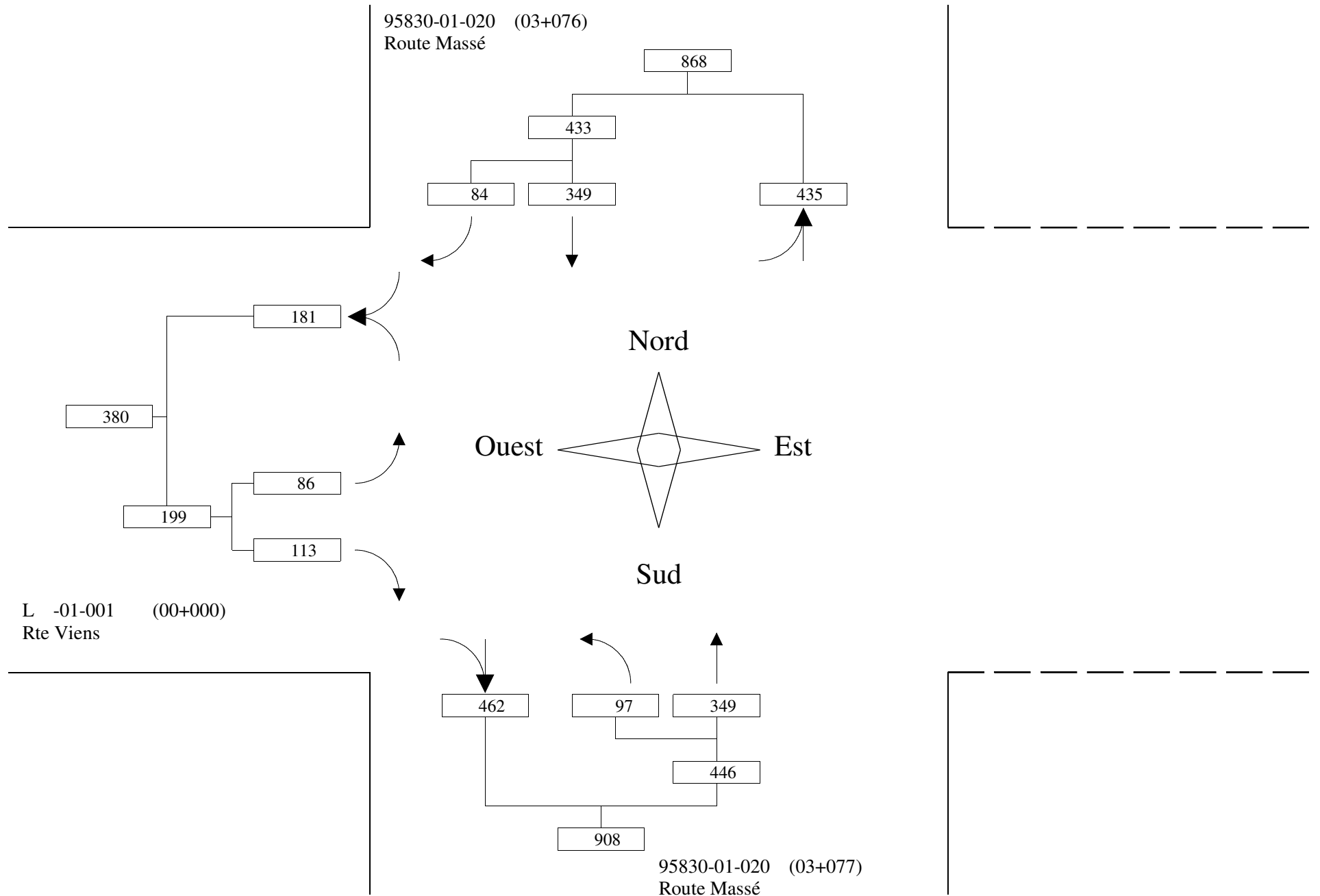



Numéro du relevé: 0056561    Municipalité: LA REDEMPTION  
 Direction Territoriale: Bas-Saint-Laurent

Avant-midi: 07-08-01 Mercredi  
 Après-midi: 07-08-01 Mercredi  
 Relevé de 7:00 à 19:00

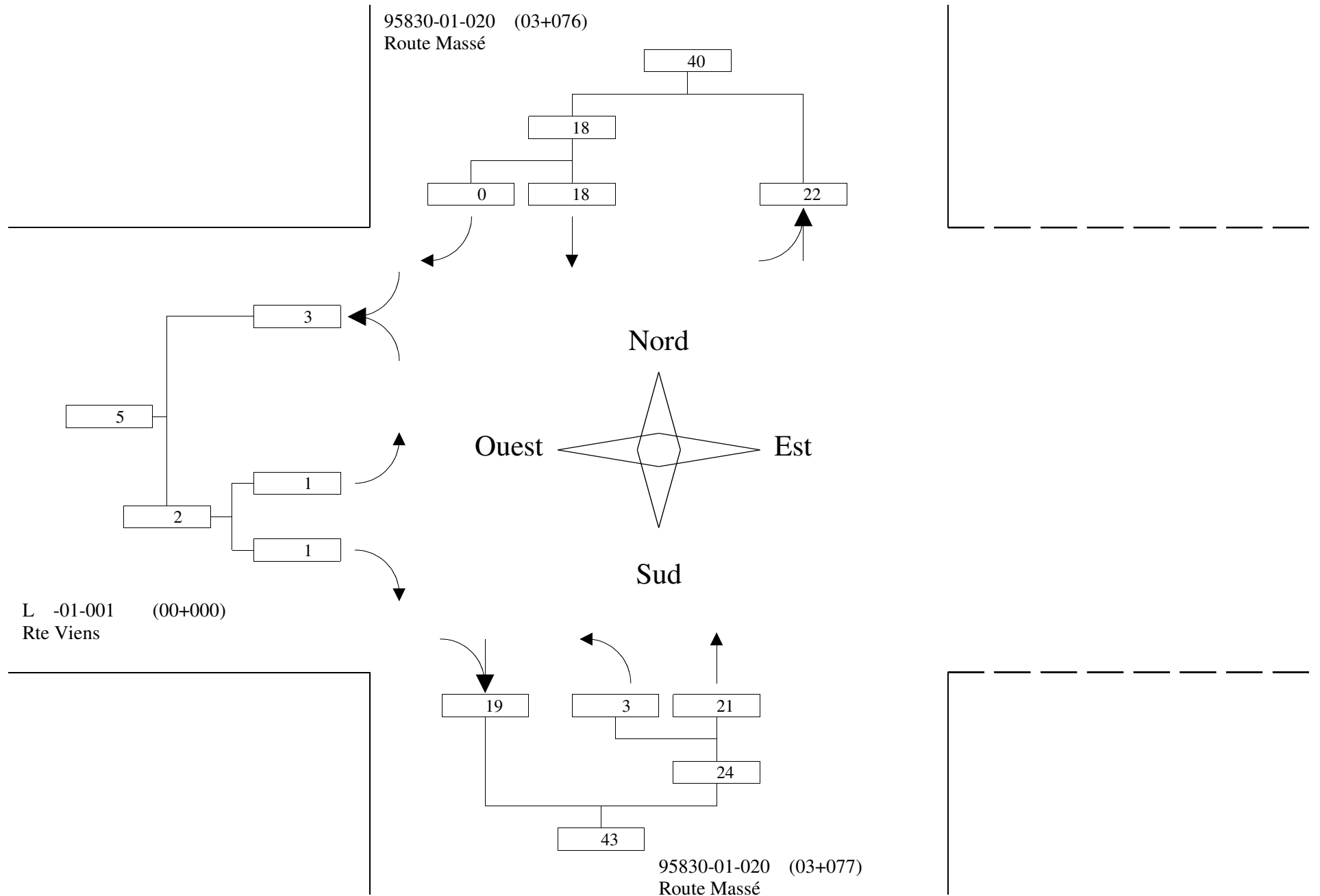

Numéro du relevé: 0056561 Municipalité: LA REDEMPTION  
Direction Territoriale: Bas-Saint-Laurent

Avant-midi: 07-08-01 Mercredi  
Après-midi: 07-08-01 Mercredi  
Relevé de 7:00 à 19:00

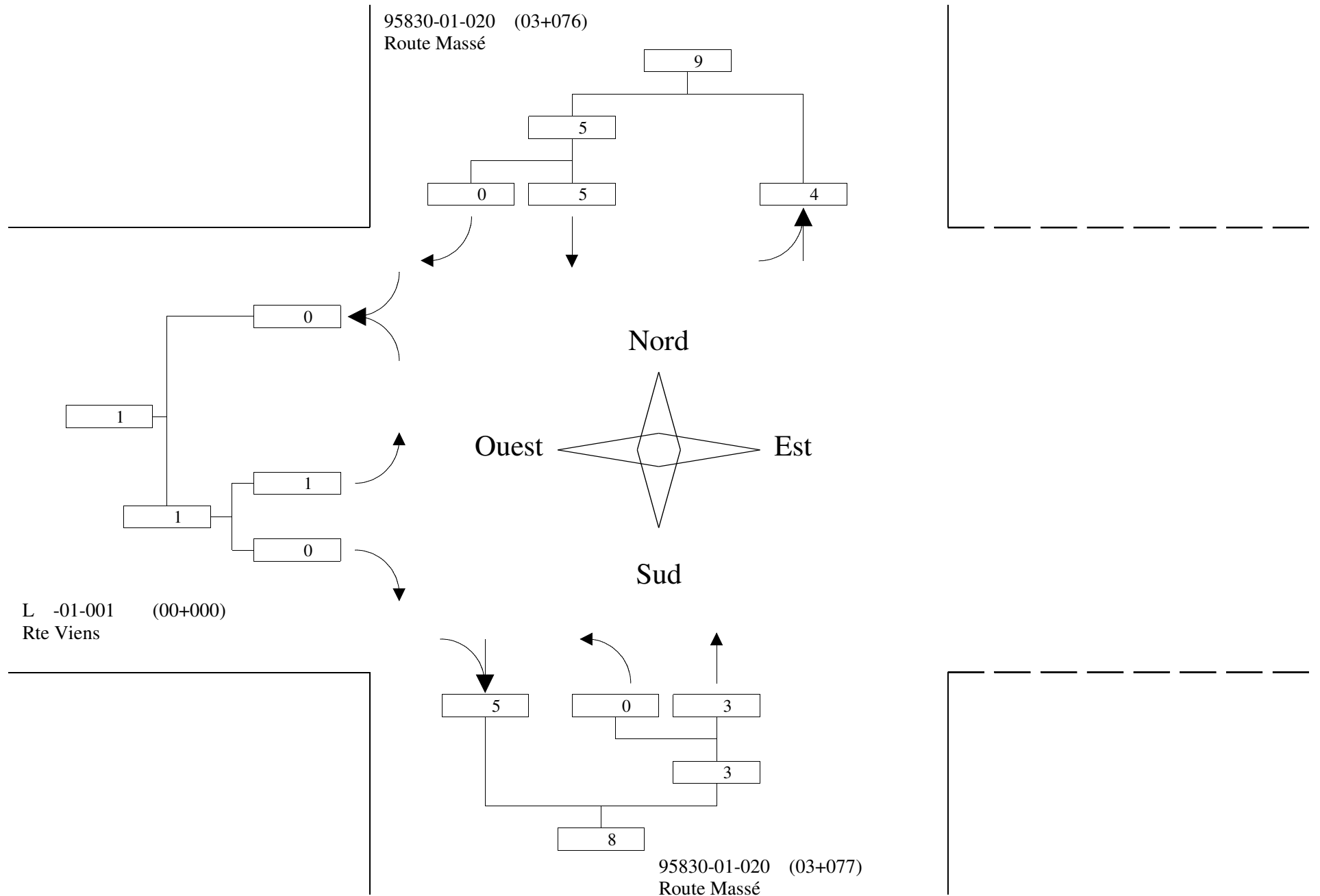

Numéro du relevé: 0056561 Municipalité: LA REDEMPTION  
Direction Territoriale: Bas-Saint-Laurent

Avant-midi: 07-08-01 Mercredi  
Après-midi: 07-08-01 Mercredi  
Relevé de 7:00 à 19:00

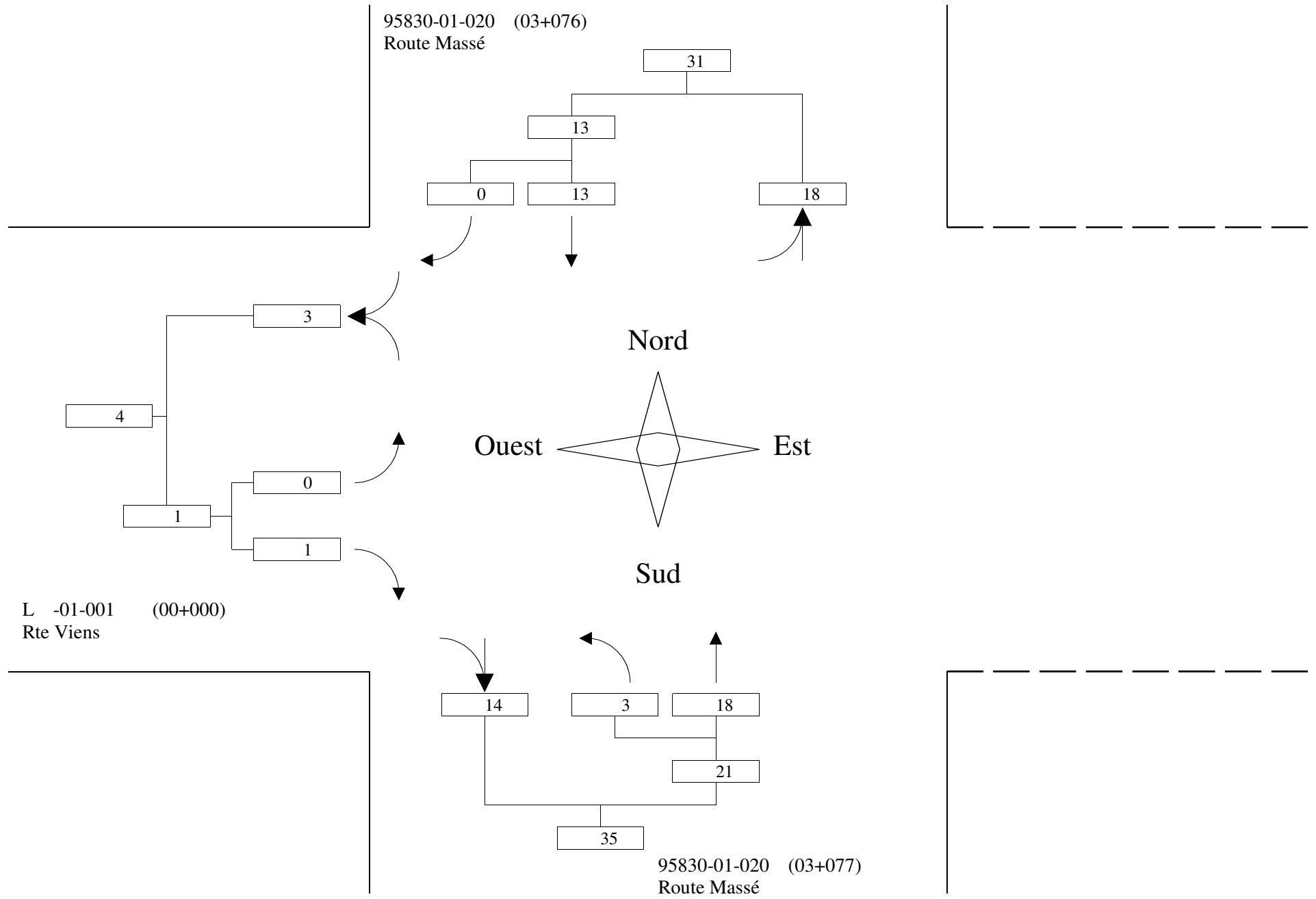

Numéro du relevé: 0056561 Municipalité: LA REDEMPTION  
Direction Territoriale: Bas-Saint-Laurent

Avant-midi: 07-08-01 Mercredi  
Après-midi: 07-08-01 Mercredi  
Relevé de 7:00 à 19:00

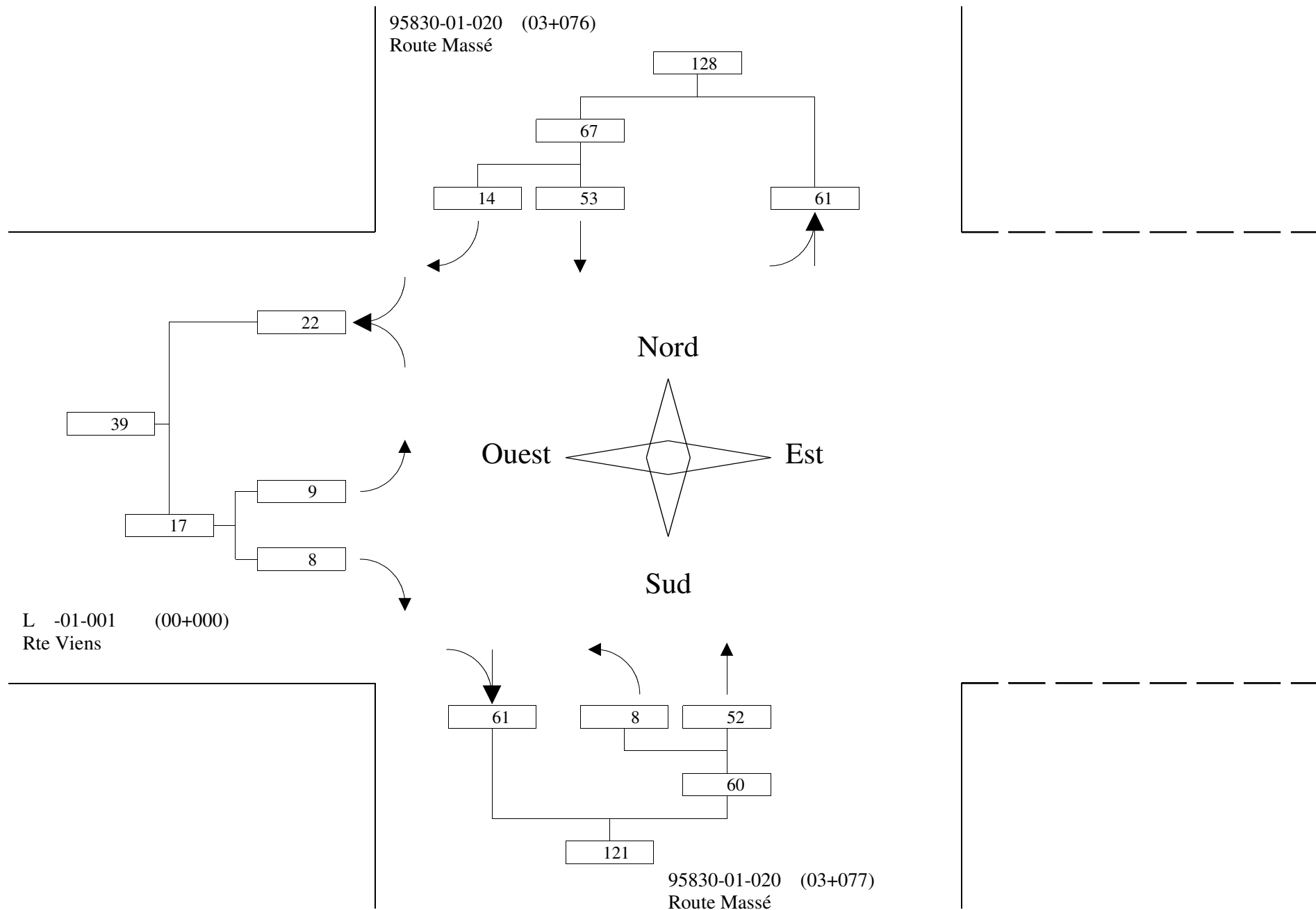

Numéro du relevé: 0056561 Municipalité: LA REDEMPTION  
 Direction Territoriale: Bas-Saint-Laurent

Avant-midi: 07-08-01 Mercredi  
 Après-midi: 07-08-01 Mercredi  
 Relevé de 7:00 à 19:00

Nord: 95830-01-020 (03+076) Route Massé  
 Sud: 95830-01-020 (03+077) Route Massé

Est:  
 Ouest: L -01-001 (00+000) Rte Viens

	Nord Route Massé			Total	Sud Route Massé			Total	Est			Total	Ouest Rte Viens			Total	Grand Total	% Horaire
	←	↑	→		←	↑	→		←	↑	→		←	↑	→			
7:00- 8:00	0	13	1	14	3	13	0	16	0	0	0	0	1	0	1	2	32	3.0
8:00- 9:00	0	14	5	19	4	19	0	23	0	0	0	0	3	0	8	11	53	4.9
9:00-10:00	0	8	1	9	7	22	0	29	0	0	0	0	3	0	12	15	53	4.9
10:00-11:00	0	30	6	36	9	23	0	32	0	0	0	0	7	0	6	13	81	7.5
11:00-12:00	0	28	6	34	11	34	0	45	0	0	0	0	9	0	13	22	101	9.4
12:00-13:00	0	53	14	67	8	52	0	60	0	0	0	0	9	0	8	17	144	13.4
13:00-14:00	0	40	4	44	12	35	0	47	0	0	0	0	12	0	11	23	114	10.6
14:00-15:00	0	22	11	33	6	24	0	30	0	0	0	0	7	0	10	17	80	7.4
15:00-16:00	0	29	7	36	9	22	0	31	0	0	0	0	10	0	11	21	88	8.2
16:00-17:00	0	40	7	47	11	34	0	45	0	0	0	0	11	0	7	18	110	10.2
17:00-18:00	0	35	13	48	14	38	0	52	0	0	0	0	5	0	10	15	115	10.7
18:00-19:00	0	37	9	46	3	33	0	36	0	0	0	0	9	0	16	25	107	9.9
<b>Total</b>	<b>0</b>	<b>349</b>	<b>84</b>	<b>433</b>	<b>97</b>	<b>349</b>	<b>0</b>	<b>446</b>	<b>0</b>	<b>0</b>	<b>0</b>	<b>0</b>	<b>86</b>	<b>0</b>	<b>113</b>	<b>199</b>	<b>1078</b>	<b>100</b>
% de approche	0.0	80.6	19.4		21.7	78.3	0.0						43.2	0.0	56.8			

Numéro du relevé: 0056561 Municipalité: LA REDEMPTION  
Direction Territoriale: Bas-Saint-Laurent

Avant-midi: 07-08-01 Mercredi  
Après-midi: 07-08-01 Mercredi  
Relevé de 7:00 à 19:00

Nord: 95830-01-020 (03+076) Route Massé  
Sud: 95830-01-020 (03+077) Route Massé

Est:  
Ouest: L -01-001 (00+000) Rte Viens

	Nord Route Massé			Total	Sud Route Massé			Total	Est			Total	Ouest Rte Viens			Total	Grand Total	% Horaire
	←	↑	→		←	↑	→		←	↑	→		←	↑	→			
7:00- 8:00	0	4	0	4	0	2	0	2	0	0	0	0	0	0	0	0	6	13.6
8:00- 9:00	0	0	0	0	0	3	0	3	0	0	0	0	0	0	0	0	3	6.8
9:00-10:00	0	2	0	2	0	1	0	1	0	0	0	0	0	0	0	0	3	6.8
10:00-11:00	0	1	0	1	0	2	0	2	0	0	0	0	0	0	0	0	3	6.8
11:00-12:00	0	2	0	2	1	1	0	2	0	0	0	0	0	0	0	0	4	9.1
12:00-13:00	0	3	0	3	0	0	0	0	0	0	0	0	0	0	0	0	3	6.8
13:00-14:00	0	0	0	0	1	1	0	2	0	0	0	0	0	0	0	0	2	4.5
14:00-15:00	0	4	0	4	0	5	0	5	0	0	0	0	0	0	1	1	10	22.7
15:00-16:00	0	2	0	2	1	2	0	3	0	0	0	0	1	0	0	1	6	13.6
16:00-17:00	0	0	0	0	0	3	0	3	0	0	0	0	0	0	0	0	3	6.8
17:00-18:00	0	0	0	0	0	0	0	0	0	0	0	0	0	0	0	0	0	0.0
18:00-19:00	0	0	0	0	0	1	0	1	0	0	0	0	0	0	0	0	1	2.3
<b>Total</b>	0	18	0	18	3	21	0	24	0	0	0	0	1	0	1	2	44	100
% de approche	0.0	100	0.0		12.5	87.5	0.0						50.0	0.0	50.0			

Numéro du relevé: 0056561 Municipalité: LA REDEMPTION  
Direction Territoriale: Bas-Saint-Laurent

Avant-midi: 07-08-01 Mercredi  
Après-midi: 07-08-01 Mercredi  
Relevé de 7:00 à 19:00

Nord: 95830-01-020 (03+076) Route Massé  
Sud: 95830-01-020 (03+077) Route Massé

Est:  
Ouest: L -01-001 (00+000) Rte Viens

	Nord Route Massé			Total	Sud Route Massé			Total	Est			Total	Ouest Rte Viens			Total	Grand Total	% Horaire
	←	↑	→		←	↑	→		←	↑	→		←	↑	→			
7:00- 8:00	0	1	0	1	0	0	0	0	0	0	0	0	0	0	0	0	1	11.1
8:00- 9:00	0	0	0	0	0	0	0	0	0	0	0	0	0	0	0	0	0	0.0
9:00-10:00	0	0	0	0	0	0	0	0	0	0	0	0	0	0	0	0	0	0.0
10:00-11:00	0	0	0	0	0	0	0	0	0	0	0	0	0	0	0	0	0	0.0
11:00-12:00	0	1	0	1	0	0	0	0	0	0	0	0	0	0	0	0	1	11.1
12:00-13:00	0	0	0	0	0	0	0	0	0	0	0	0	0	0	0	0	0	0.0
13:00-14:00	0	0	0	0	0	0	0	0	0	0	0	0	0	0	0	0	0	0.0
14:00-15:00	0	2	0	2	0	2	0	2	0	0	0	0	0	0	0	0	4	44.4
15:00-16:00	0	1	0	1	0	0	0	0	0	0	0	0	1	0	0	1	2	22.2
16:00-17:00	0	0	0	0	0	1	0	1	0	0	0	0	0	0	0	0	1	11.1
17:00-18:00	0	0	0	0	0	0	0	0	0	0	0	0	0	0	0	0	0	0.0
18:00-19:00	0	0	0	0	0	0	0	0	0	0	0	0	0	0	0	0	0	0.0
<b>Total</b>	<b>0</b>	<b>5</b>	<b>0</b>	<b>5</b>	<b>0</b>	<b>3</b>	<b>0</b>	<b>3</b>	<b>0</b>	<b>0</b>	<b>0</b>	<b>0</b>	<b>1</b>	<b>0</b>	<b>0</b>	<b>1</b>	<b>9</b>	<b>100</b>
% de approche	0.0	100	0.0		0.0	100	0.0						100	0.0	0.0			

Numéro du relevé: 0056561 Municipalité: LA REDEMPTION  
Direction Territoriale: Bas-Saint-Laurent

Avant-midi: 07-08-01 Mercredi  
Après-midi: 07-08-01 Mercredi  
Relevé de 7:00 à 19:00

Nord: 95830-01-020 (03+076) Route Massé  
Sud: 95830-01-020 (03+077) Route Massé

Est:  
Ouest: L -01-001 (00+000) Rte Viens

	Nord Route Massé			Total	Sud Route Massé			Total	Est			Total	Ouest Rte Viens			Total	Grand Total	% Horaire
	←	↑	→		←	↑	→		←	↑	→		←	↑	→			
7:00- 8:00	0	3	0	3	0	2	0	2	0	0	0	0	0	0	0	0	5	14.3
8:00- 9:00	0	0	0	0	0	3	0	3	0	0	0	0	0	0	0	0	3	8.6
9:00-10:00	0	2	0	2	0	1	0	1	0	0	0	0	0	0	0	0	3	8.6
10:00-11:00	0	1	0	1	0	2	0	2	0	0	0	0	0	0	0	0	3	8.6
11:00-12:00	0	1	0	1	1	1	0	2	0	0	0	0	0	0	0	0	3	8.6
12:00-13:00	0	3	0	3	0	0	0	0	0	0	0	0	0	0	0	0	3	8.6
13:00-14:00	0	0	0	0	1	1	0	2	0	0	0	0	0	0	0	0	2	5.7
14:00-15:00	0	2	0	2	0	3	0	3	0	0	0	0	0	0	1	1	6	17.1
15:00-16:00	0	1	0	1	1	2	0	3	0	0	0	0	0	0	0	0	4	11.4
16:00-17:00	0	0	0	0	0	2	0	2	0	0	0	0	0	0	0	0	2	5.7
17:00-18:00	0	0	0	0	0	0	0	0	0	0	0	0	0	0	0	0	0	0.0
18:00-19:00	0	0	0	0	0	1	0	1	0	0	0	0	0	0	0	0	1	2.9
<b>Total</b>	<b>0</b>	<b>13</b>	<b>0</b>	<b>13</b>	<b>3</b>	<b>18</b>	<b>0</b>	<b>21</b>	<b>0</b>	<b>0</b>	<b>0</b>	<b>0</b>	<b>0</b>	<b>0</b>	<b>1</b>	<b>1</b>	<b>35</b>	<b>100</b>
% de approche	0.0	100	0.0		14.3	85.7	0.0						0.0	0.0	100			



Numéro du relevé: 0056561 Municipalité: LA REDEMPTION  
Direction Territoriale: Bas-Saint-Laurent

Avant-midi: 07-08-01 Mercredi  
Après-midi: 07-08-01 Mercredi  
Relevé de 7:00 à 19:00

Nord: 95830-01-020 (03+076) Route Massé  
Sud: 95830-01-020 (03+077) Route Massé

Est:  
Ouest: L -01-001 (00+000) Rte Viens

	Nord Route Massé				Sud Route Massé				Est				Ouest Rte Viens				Grand Total
	←	↑	→	Total	←	↑	→	Total	←	↑	→	Total	←	↑	→	Total	
9:00- 9:15	0	4	1	5	1	5	0	6	0	0	0	0	0	0	4	4	15
9:15- 9:30	0	2	0	2	3	4	0	7	0	0	0	0	0	0	3	3	12
9:30- 9:45	0	0	0	0	2	5	0	7	0	0	0	0	3	0	3	6	13
9:45-10:00	0	2	0	2	1	8	0	9	0	0	0	0	0	0	2	2	13
Total pointe		8	1	9	7	22		29					3		12	15	53
fpi		0.50	0.25	0.45	0.58	0.69		0.81					0.25		0.75	0.63	0.88
% commercial		25.0	0.0	22.2	0.0	4.5		3.4					0.0		0.0	0.0	5.7
12:00-12:15	0	8	4	12	6	10	0	16	0	0	0	0	3	0	3	6	34
12:15-12:30	0	11	4	15	2	10	0	12	0	0	0	0	2	0	2	4	31
12:30-12:45	0	18	3	21	0	16	0	16	0	0	0	0	0	0	2	2	39
12:45-13:00	0	16	3	19	0	16	0	16	0	0	0	0	4	0	1	5	40
Total pointe		53	14	67	8	52		60					9		8	17	144
fpi		0.74	0.88	0.80	0.33	0.81		0.94					0.56		0.67	0.71	0.90
% commercial		5.7	0.0	4.5	0.0	0.0		0.0					0.0		0.0	0.0	2.1
16:30-16:45	0	12	2	14	3	9	0	12	0	0	0	0	5	0	2	7	33
16:45-17:00	0	13	0	13	3	15	0	18	0	0	0	0	2	0	2	4	35
17:00-17:15	0	10	4	14	4	15	0	19	0	0	0	0	1	0	2	3	36
17:15-17:30	0	11	5	16	6	11	0	17	0	0	0	0	1	0	4	5	38
Total pointe		46	11	57	16	50		66					9		10	19	142
fpi		0.88	0.55	0.89	0.67	0.83		0.87					0.45		0.63	0.68	0.93
% commercial		0.0	0.0	0.0	0.0	4.0		3.0					0.0		0.0	0.0	1.4

Numéro du relevé: 0056561 Municipalité: LA REDEMPTION  
Direction Territoriale: Bas-Saint-Laurent

Avant-midi: 07-08-01 Mercredi  
Après-midi: 07-08-01 Mercredi  
Relevé de 7:00 à 19:00

Nord: 95830-01-020 (03+076) Route Massé  
Sud: 95830-01-020 (03+077) Route Massé

Est:  
Ouest: L -01-001 (00+000) Rte Viens

Type1: Direction 1

Type2: Direction 2

Type3: --nil--

	Nord Route Massé				Sud Route Massé				Est				Ouest Rte Viens				Grand Total
	o->e	e->o	Type3	Total	e->o	o->e	Type3	Total	n->s	s->n	Type3	Total	s->n	n->s	Type3	Total	
	7:00- 7:15	0	0	0	0	0	0	0	0	0	0	0	0	0	0	0	
7:15- 7:30	0	0	0	0	0	0	0	0	0	0	0	0	0	0	0	0	0
7:30- 7:45	0	0	0	0	0	0	0	0	0	0	0	0	0	0	0	0	0
7:45- 8:00	0	0	0	0	0	0	0	0	0	0	0	0	0	0	0	0	0
8:00- 8:15	0	0	0	0	0	0	0	0	0	0	0	0	0	0	0	0	0
8:15- 8:30	0	0	0	0	0	0	0	0	0	0	0	0	0	0	0	0	0
8:30- 8:45	0	0	0	0	0	0	0	0	0	0	0	0	0	0	0	0	0
8:45- 9:00	0	0	0	0	0	0	0	0	0	0	0	0	0	0	0	0	0
9:00- 9:15	0	0	0	0	0	0	0	0	0	0	0	0	0	0	0	0	0
9:15- 9:30	0	0	0	0	0	0	0	0	0	0	0	0	0	0	0	0	0
9:30- 9:45	0	0	0	0	0	0	0	0	0	0	0	0	1	0	0	1	1
9:45-10:00	1	1	0	2	0	0	0	0	0	0	0	0	1	1	0	2	4
10:00-10:15	0	1	0	1	2	0	0	2	0	0	0	0	0	1	0	1	4
10:15-10:30	1	0	0	1	1	0	0	1	0	0	0	0	1	1	0	2	4
10:30-10:45	1	0	0	1	0	0	0	0	0	0	0	0	1	0	0	1	2
10:45-11:00	0	0	0	0	0	0	0	0	0	0	0	0	0	1	0	1	1
11:00-11:15	0	0	0	0	0	0	0	0	0	0	0	0	4	3	0	7	7
11:15-11:30	0	0	0	0	0	0	0	0	0	0	0	0	0	0	0	0	0
11:30-11:45	0	0	0	0	1	0	0	1	0	0	0	0	1	0	0	1	2
11:45-12:00	0	0	0	0	0	0	0	0	0	0	0	0	0	0	0	0	0
12:00-12:15	1	1	0	2	0	0	0	0	0	0	0	0	1	0	0	1	3
12:15-12:30	0	1	0	1	0	0	0	0	0	0	0	0	0	2	0	2	3
12:30-12:45	1	0	0	1	0	0	0	0	0	0	0	0	0	0	0	0	1
12:45-13:00	0	0	0	0	0	0	0	0	0	0	0	0	1	0	0	1	1

Numéro du relevé: 0056561 Municipalité: LA REDEMPTION  
Direction Territoriale: Bas-Saint-Laurent

Avant-midi: 07-08-01 Mercredi  
Après-midi: 07-08-01 Mercredi  
Relevé de 7:00 à 19:00

Nord: 95830-01-020 (03+076) Route Massé  
Sud: 95830-01-020 (03+077) Route Massé

Est:  
Ouest: L -01-001 (00+000) Rte Viens

Type1: Direction 1

Type2: Direction 2

Type3: --nil--

	Nord				Sud				Est				Ouest				Grand Total
	Route Massé				Route Massé								Rte Viens				
	o->e	e->o	Type3	Total	e->o	o->e	Type3	Total	n->s	s->n	Type3	Total	s->n	n->s	Type3	Total	
13:00-13:15	0	0	0	0	0	0	0	0	0	0	0	0	1	1	0	2	2
13:15-13:30	0	0	0	0	0	0	0	0	0	0	0	0	0	1	0	1	1
13:30-13:45	0	0	0	0	0	0	0	0	0	0	0	0	0	0	0	0	0
13:45-14:00	0	0	0	0	0	0	0	0	0	0	0	0	0	0	0	0	0
14:00-14:15	0	0	0	0	2	1	0	3	0	0	0	0	0	0	0	0	3
14:15-14:30	0	0	0	0	0	2	0	2	0	0	0	0	0	0	0	0	2
14:30-14:45	0	0	0	0	0	0	0	0	0	0	0	0	0	0	0	0	0
14:45-15:00	1	1	0	2	0	0	0	0	0	0	0	0	0	0	0	0	2
15:00-15:15	0	2	0	2	0	0	0	0	0	0	0	0	0	1	0	1	3
15:15-15:30	0	0	0	0	0	0	0	0	0	0	0	0	0	1	0	1	1
15:30-15:45	0	0	0	0	0	0	0	0	0	0	0	0	0	0	0	0	0
15:45-16:00	0	0	0	0	0	0	0	0	0	0	0	0	0	0	0	0	0
16:00-16:15	1	1	0	2	0	0	0	0	0	0	0	0	5	0	0	5	7
16:15-16:30	4	0	0	4	0	0	0	0	0	0	0	0	0	0	0	0	4
16:30-16:45	0	0	0	0	0	0	0	0	0	0	0	0	0	0	0	0	0
16:45-17:00	1	0	0	1	0	0	0	0	0	0	0	0	0	1	0	1	2
17:00-17:15	0	1	0	1	0	0	0	0	0	0	0	0	0	0	0	0	1
17:15-17:30	2	2	0	4	0	0	0	0	0	0	0	0	0	2	0	2	6
17:30-17:45	0	0	0	0	0	0	0	0	0	0	0	0	0	0	0	0	0
17:45-18:00	0	0	0	0	0	0	0	0	0	0	0	0	2	0	0	2	2
18:00-18:15	0	0	0	0	0	0	0	0	0	0	0	0	0	0	0	0	0
18:15-18:30	0	1	0	1	0	0	0	0	0	0	0	0	0	0	0	0	1
18:30-18:45	0	0	0	0	0	0	0	0	0	0	0	0	0	0	0	0	0
18:45-19:00	3	0	0	3	0	0	0	0	0	0	0	0	1	0	0	1	4
Total	17	12	0	29	6	3	0	9	0	0	0	0	20	16	0	36	74

Numéro du relevé: 0056561 Municipalité: LA REDEMPTION  
Direction Territoriale: Bas-Saint-Laurent

Avant-midi: 07-08-01 Mercredi  
Après-midi: 07-08-01 Mercredi  
Relevé de 7:00 à 19:00

Nord: 95830-01-020 (03+076) Route Massé  
Sud: 95830-01-020 (03+077) Route Massé

Est:  
Ouest: L -01-001 (00+000) Rte Viens

	Nord Route Massé			Total	Sud Route Massé			Total	Est			Total	Ouest Rte Viens			Total	Grand Total	%
	←	↑	→		←	↑	→		←	↑	→		←	↑	→			
7:00- 7:15	0	3	1	4	1	2	0	3	0	0	0	0	0	0	0	0	7	0.6
7:15- 7:30	0	2	0	2	0	3	0	3	0	0	0	0	1	0	0	1	6	0.6
7:30- 7:45	0	6	0	6	1	4	0	5	0	0	0	0	0	0	0	0	11	1.0
7:45- 8:00	0	2	0	2	1	4	0	5	0	0	0	0	0	0	1	1	8	0.7
8:00- 8:15	0	6	1	7	0	5	0	5	0	0	0	0	1	0	3	4	16	1.5
8:15- 8:30	0	4	3	7	0	4	0	4	0	0	0	0	0	0	1	1	12	1.1
8:30- 8:45	0	2	0	2	3	4	0	7	0	0	0	0	1	0	2	3	12	1.1
8:45- 9:00	0	2	1	3	1	6	0	7	0	0	0	0	1	0	2	3	13	1.2
9:00- 9:15	0	4	1	5	1	5	0	6	0	0	0	0	0	0	4	4	15	1.4
9:15- 9:30	0	2	0	2	3	4	0	7	0	0	0	0	0	0	3	3	12	1.1
9:30- 9:45	0	0	0	0	2	5	0	7	0	0	0	0	3	0	3	6	13	1.2
9:45-10:00	0	2	0	2	1	8	0	9	0	0	0	0	0	0	2	2	13	1.2
10:00-10:15	0	3	2	5	3	5	0	8	0	0	0	0	4	0	3	7	20	1.9
10:15-10:30	0	12	1	13	1	7	0	8	0	0	0	0	0	0	1	1	22	2.0
10:30-10:45	0	5	2	7	4	4	0	8	0	0	0	0	0	0	0	0	15	1.4
10:45-11:00	0	10	1	11	1	7	0	8	0	0	0	0	3	0	2	5	24	2.2
11:00-11:15	0	8	0	8	3	10	0	13	0	0	0	0	3	0	4	7	28	2.6
11:15-11:30	0	8	1	9	0	7	0	7	0	0	0	0	3	0	6	9	25	2.3
11:30-11:45	0	6	1	7	6	10	0	16	0	0	0	0	0	0	1	1	24	2.2
11:45-12:00	0	6	4	10	2	7	0	9	0	0	0	0	3	0	2	5	24	2.2
12:00-12:15	0	8	4	12	6	10	0	16	0	0	0	0	3	0	3	6	34	3.2
12:15-12:30	0	11	4	15	2	10	0	12	0	0	0	0	2	0	2	4	31	2.9
12:30-12:45	0	18	3	21	0	16	0	16	0	0	0	0	0	0	2	2	39	3.6
12:45-13:00	0	16	3	19	0	16	0	16	0	0	0	0	4	0	1	5	40	3.7

Numéro du relevé: 0056561 Municipalité: LA REDEMPTION  
Direction Territoriale: Bas-Saint-Laurent

Avant-midi: 07-08-01 Mercredi  
Après-midi: 07-08-01 Mercredi  
Relevé de 7:00 à 19:00

Nord: 95830-01-020 (03+076) Route Massé  
Sud: 95830-01-020 (03+077) Route Massé

Est:  
Ouest: L -01-001 (00+000) Rte Viens

	Nord Route Massé				Sud Route Massé				Est				Ouest Rte Viens				Grand Total	%
	←	↑	→	Total	←	↑	→	Total	←	↑	→	Total	←	↑	→	Total		
13:00-13:15	0	7	1	8	3	5	0	8	0	0	0	0	3	0	3	6	22	2.0
13:15-13:30	0	14	2	16	1	10	0	11	0	0	0	0	5	0	2	7	34	3.2
13:30-13:45	0	10	1	11	5	12	0	17	0	0	0	0	3	0	4	7	35	3.2
13:45-14:00	0	9	0	9	3	8	0	11	0	0	0	0	1	0	2	3	23	2.1
14:00-14:15	0	6	3	9	0	5	0	5	0	0	0	0	3	0	2	5	19	1.8
14:15-14:30	0	4	2	6	3	5	0	8	0	0	0	0	4	0	1	5	19	1.8
14:30-14:45	0	7	1	8	2	5	0	7	0	0	0	0	0	0	4	4	19	1.8
14:45-15:00	0	5	5	10	1	9	0	10	0	0	0	0	0	0	3	3	23	2.1
15:00-15:15	0	5	1	6	3	5	0	8	0	0	0	0	2	0	1	3	17	1.6
15:15-15:30	0	7	5	12	4	5	0	9	0	0	0	0	5	0	1	6	27	2.5
15:30-15:45	0	9	0	9	1	7	0	8	0	0	0	0	3	0	6	9	26	2.4
15:45-16:00	0	8	1	9	1	5	0	6	0	0	0	0	0	0	3	3	18	1.7
16:00-16:15	0	11	2	13	1	4	0	5	0	0	0	0	2	0	1	3	21	1.9
16:15-16:30	0	4	3	7	4	6	0	10	0	0	0	0	2	0	2	4	21	1.9
16:30-16:45	0	12	2	14	3	9	0	12	0	0	0	0	5	0	2	7	33	3.1
16:45-17:00	0	13	0	13	3	15	0	18	0	0	0	0	2	0	2	4	35	3.2
17:00-17:15	0	10	4	14	4	15	0	19	0	0	0	0	1	0	2	3	36	3.3
17:15-17:30	0	11	5	16	6	11	0	17	0	0	0	0	1	0	4	5	38	3.5
17:30-17:45	0	5	2	7	2	3	0	5	0	0	0	0	2	0	1	3	15	1.4
17:45-18:00	0	9	2	11	2	9	0	11	0	0	0	0	1	0	3	4	26	2.4
18:00-18:15	0	6	1	7	1	6	0	7	0	0	0	0	5	0	0	5	19	1.8
18:15-18:30	0	7	7	14	1	6	0	7	0	0	0	0	1	0	9	10	31	2.9
18:30-18:45	0	9	0	9	1	14	0	15	0	0	0	0	2	0	5	7	31	2.9
18:45-19:00	0	15	1	16	0	7	0	7	0	0	0	0	1	0	2	3	26	2.4



